



ELSEVIER

Discrete Mathematics 155 (1996) 173–181

DISCRETE
MATHEMATICS

Straight-line representations of maps on the torus and other flat surfaces

Bojan Mohar¹

University of Ljubljana, Department of Mathematics, Jadranska 19, 61111 Ljubljana, Slovenia

Received 10 January 1993

Abstract

It is shown that every map on the torus satisfying the obvious necessary conditions has a straight-line representation on the flat torus $\mathbf{R}^2/\mathbf{Z}^2$. The same holds for the Klein bottle, and the two-bordered flat surfaces — the cylinder and the Möbius band.

1. Straight-line maps

By a well-known result of Wagner [13] (usually attributed to Fáry [4]), every simple plane graph admits a straight-line representation, i.e. there is a homeomorphism of the plane such that the edges of the graph become straight-line segments after performing this homeomorphism. A companion result is the theorem of Steinitz [11] that every 3-connected planar graph can be represented as the graph of a convex 3-polytope. There were attempts to generalize Steinitz's theorem to maps on surfaces of positive genus, e.g. [5,9]. But it seems that no one tried to extend the Wagner–Fáry's Theorem to non-simply connected surfaces. In this paper we fill in this gap by proving a corresponding result for the torus, the Klein bottle, the cylinder, and the Möbius band. These are the only flat surfaces with the boundary components being straight. The existence of straight-line representations of maps on the torus and the Klein bottle might have some applications in the theory of tilings of the plane since their universal covers give rise to plane tilings. A short discussion about this can be found in [7, p. 202].

Our proof of the existence of straight-line representations is fairly elementary. It can be extended to surfaces of higher genera, applied to their models with constant

¹ Supported in part by the Ministry for Science and Technology of Slovenia, Research Project P1-0210-101-92.

curvature -1 (the hyperbolic metric), and with the geodesics playing the role of straight-line segments. We will not give details for these cases since it recently came to our attention that the existence of such geodesic representations (for surfaces without boundary) follows from the Circle Packing Theorem of Koebe [8], Andreev [1,2], and Thurston [12]. The advantage of our proof compared to the circle packing results is that it is elementary and that it also yields a polynomial-time algorithm to produce straight-line drawings of given maps.

Let S be a compact surface. A *map* on S is a pair $M = (G, S)$, where G is a connected graph embedded in S . To get more freedom, we do not require the embedding to be cellular, so a map can have non-simply connected faces. If S has non-empty boundary, $\partial S \neq \emptyset$, then we require for each edge of G either to be disjoint from ∂S , having only one or both endvertices on ∂S , or entirely lying on ∂S . A map on the torus is also said to be a *toroidal map*. Two maps $M = (G, S)$ and $M' = (G', S')$ are *equivalent* if there is a homeomorphism $h : S \rightarrow S'$ mapping the graph G of the first map isomorphically to the graph G' of the second map. It is well-known (cf., e.g., [6,10]) that two maps on an orientable surface without boundary and with all faces simply connected are equivalent if and only if they determine the same rotation system on the graph.

A compact Riemannian surface S (possibly with boundary) is *flat* if every point $p \in S$ has a neighbourhood which is affinely diffeomorphic to an open set in the closed upper half-plane of the Euclidean plane. This is equivalent to the condition that the curvature and torsion are identically zero, including the curvature of the boundary ∂S . The special case of a flat surface is the *flat torus*, the quotient space $\mathbf{R}^2/\mathbf{Z}^2$ (\mathbf{R}^2/\sim where $(x, y) \sim (x', y')$ means $(x - x', y - y') \in \mathbf{Z}^2$). Another flat surface is the *flat Klein bottle*. This surface is the quotient of the Euclidean plane \mathbf{R}^2 corresponding to the relation \sim given by $(x, y) \sim (x + n, (-1)^n y + m)$, $n, m \in \mathbf{Z}$. The flat torus and the flat Klein bottle are usually represented as the identification space of the unit square by identifying the top and the bottom side and then identifying the left and the right, with a previous turn by 180° in case of the Klein bottle. There are two additional flat surfaces with boundary — the *flat cylinder* and the *flat Möbius band*. They are obtained from the unit square as well, by identifying only one pair of sides, the left and the right. To get the cylinder they are identified without a turn, and to get the Möbius band we perform a twist of 180° of one side before the identification. It can be shown by using the Gauss–Bonnet formula (cf. [3]) that every compact flat surface is homeomorphic to one of these four surfaces.

A *straight-line segment* on a flat surface S is a segment of a geodesic on S . A map M on S is said to be a *straight-line map* if each edge of the graph of M is a straight-line segment. Every straight-line map M on S is *simple*, i.e. M has the following properties (see Fig. 1):

1. Each pair of parallel edges (edges with the same endvertices) gives rise to a noncontractible cycle on S .
2. No loop of M is contractible.

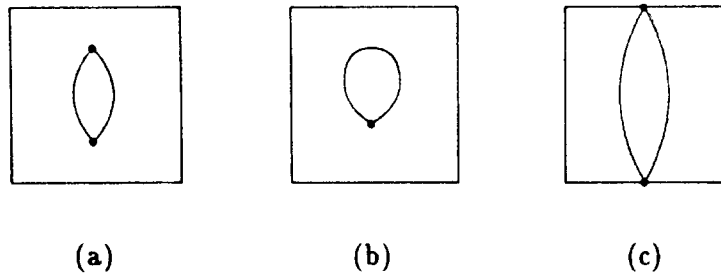

Fig. 1. Forbidden submaps of simple maps.

3. If e is a loop at the vertex v then no other loop at v is homotopic to e (i.e., does not bound a disk together with e).

This is easily seen by using the Gauss–Bonnet formula (cf. [3]). It is clear that the map is simple if and only if its universal cover has no loops and no parallel edges.

For the flat torus and other flat surfaces we will also prove the converse: A map on a flat surface is equivalent to a straight-line map if and only if it is simple (Theorems 3.1, 4.1, 5.2).

2. Triangular maps and contractible edges

A map $M = (G, S)$ is *triangular* if $\partial S \subseteq G$ and every face is of size three and homeomorphic to an open disk. The smallest triangular simple map on the torus is shown in Fig. 2. Its graph consists of a single vertex with three loops. We will show that every triangular simple map on the torus can be reduced to the map of Fig. 2 by means of edge contractions.

Let M be a triangular simple map. An interior edge e of M is *contractible* if the operation shown in Fig. 3 gives rise to another simple map on the same surface. Notice the edges α, β , and, respectively, γ, δ , of the two triangles containing e , are pairwise identified after the contraction. An edge e on the boundary of the surface is *contractible* if the similar operation as shown on Fig. 3, adopted to the fact

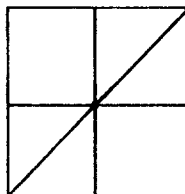

Fig. 2. The simplest simple triangular map on the torus.

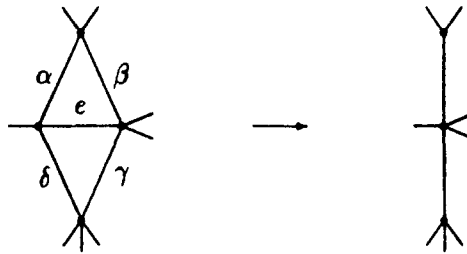

Fig. 3. Edge contraction.

that e is contained in only one triangular face, gives rise to a simple map on the same surface. Call an edge of $M = (G, S)$ *potentially contractible* if it is not a loop and it is either contained in ∂S , or one of its ends is not on ∂S . In other words, a contraction of an edge which is not potentially contractible, would change the homeomorphism type of the surface. By definition of a contraction, any contractible edge is potentially contractible. The map arising after the contraction of e is denoted by $M // e$.

Lemma 2.1. *If M is a simple triangular map containing at least one potentially contractible edge then M contains a contractible edge.*

Proof. Let e be a potentially contractible edge of M and suppose that $M // e$ is not simple. Since M contains no contractible digons, the only reasons for this to happen are:

- (i) we get a pair α, β of parallel edges bounding a disc, or
- (ii) we get a pair α, β of homotopic loops.

In each case α and β bound a disk in $M // e$. This implies that α, β , and e bound a disk in M . Denote by F this disk (cf. Fig. 4 for the actual possibilities in case when e is an interior edge).

Assume now that M contains no contractible edge. Among all potentially contractible edges e choose one (and a pair α, β) for which the corresponding disk F contains the smallest number of faces of M . Since the edges α, β become a homotopic pair of parallel edges or loops after the contraction of e , there must be at least one vertex of G in the interior of F . This is seen as follows. M is triangular. In case when F is bounded by exactly three edges (Fig. 4(b) or (d)), F must contain an interior vertex, since F is not facial. In the remaining cases F is a 4-gon (Fig. 4(a) and (c)). Having a chord in F we get a contradiction with the minimality of F since the chord can replace α or β . Therefore, F contains an interior vertex also in this case. Let f be an edge adjacent to a vertex in the interior of F . Then f is not a loop, and by the minimality of F , it follows easily that f is contractible. This contradicts our initial assumption. \square

Lemma 2.2. *Let M be a simple triangular map on a flat surface S , and e a contractible edge of M . If $M' = M // e$ has a straight-line representation on S then the*

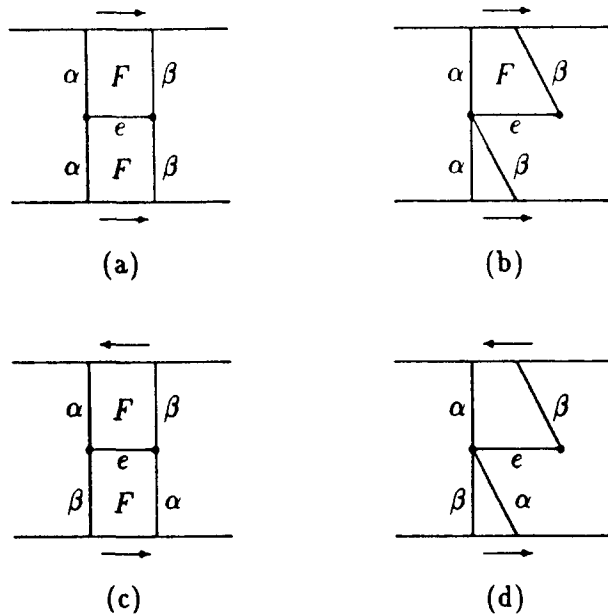

Fig. 4. Obtaining homotopic loops.

same is true for M . Moreover, for each $\varepsilon > 0$ there is a straight-line representation of M such that the edge lengths of M exceed the maximal edge length of M' by at most ε .

Proof. Let x be the vertex of M' corresponding to e . It is easy to see that one can replace x by a very short straight-line segment representing e and being able to draw all the edges of M adjacent to e using straight-line segments. (To show this one can use the fact that for each edge f of M' there is a small enough $\delta > 0$ such that in the δ -neighbourhood $nb\delta(f, \delta) := \{p \in M \mid \text{dist}(p, f) \leq \delta\}$ of f any two points can be joined by a straight-line segment entirely lying in $nb\delta(f, \delta)$.) If the length of e is smaller than ε then by the triangular inequality the new edge lengths cannot increase by more than ε . \square

Lemma 2.3. Every simple map is contained in a triangular simple map on the same surface.

Proof. It is well-known that every (simple) map is a submap of a (simple) map on the same surface with all faces homeomorphic to a 2-cell and such that the boundary of the surface is covered by the graph of the map. Given a map M we may therefore assume M has these properties.

Let M be a simple map. Consider a face F of M . Let $v_0, e_1, v_1, e_2, \dots, v_{k-1}, e_k, v_k = v_0$ be the facial walk of F , where e_i ($1 \leq i \leq k$) is an edge of M joining vertices v_{i-1}

and v_i on the boundary of F . Add in F new vertices v'_1, \dots, v'_k and w , and join for $i = 1, 2, \dots, k$ vertices v_i and v'_i , v_i and v'_{i+1} , v'_i and v'_{i+1} (indices modulo k), and v'_i and w . It is easy to see that this can be done so that the resulting faces replacing F are all triangular. The new map is still simple since we have not changed the original map and have not introduced loops or homotopic parallel edges. (Parallel edges may appear only if an edge e_i is a loop. But in this case the parallel pair is homotopic to e_i which is non-contractible.) By performing this operation in every face of M we find a required map. \square

3. The torus

Let us apply the results of the previous section to the case when the surface S is the torus.

Theorem 3.1. *A toroidal map is equivalent to a straight-line map on the flat torus if and only if it is simple.*

Proof. Theorem 3.1 is a simple corollary of Lemmas 2.1–2.3 and the straight-line representation of the simple map of Fig. 2 if we prove that every simple triangular toroidal map without potentially contractible edges is equivalent to the map of Fig. 2. Since the torus has no boundary, a map without potentially contractible edges has only one vertex. By the Euler's formula we see that there are exactly three loops based at this vertex. Now it is an easy task to see that the only possible local rotation of this graph giving a simple triangular map is the one given in Fig. 2. \square

The above proof actually gives a polynomial-time algorithm for constructing straight-line representations of simple toroidal maps.

It is a simple consequence of Lemma 2.2 that for an arbitrary $\varepsilon > 0$, a simple toroidal map has a straight-line representation where each edge has length at most $\sqrt{2} + \varepsilon$. Such a representation can be obtained by requiring that the length of the edge obtained by a vertex splitting on the k th step is at most $\varepsilon/2^k$.

Instead of beginning with Fig. 2, one could as well start with an equivalent map, for example the one in Fig. 5. In such a case we also get straight-line representations of simple toroidal maps, unfortunately with much less handsome final outlook.

4. The Klein bottle

The Klein bottle is another surface with everywhere flat metric. Its standard model is obtained from the unit square in the plane by first identifying the top and the bottom

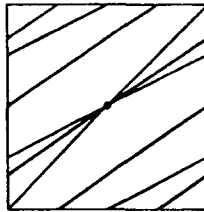

Fig. 5. Straight-line map equivalent to the map of Fig. 2.

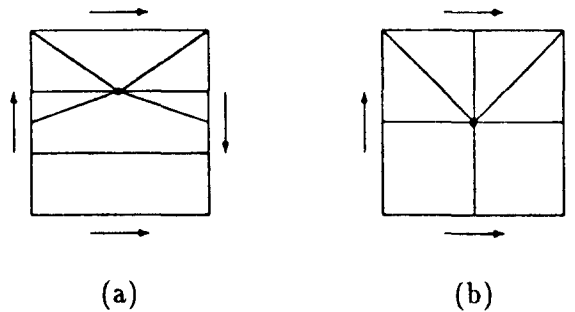

Fig. 6. The simplest simple triangular maps on the Klein bottle.

and then the left and the right side, but these two are identified after a flip by 180° of one of them, so that the lower points on the left are identified with the top points on the right, and vice versa.

Theorem 4.1. *Every simple map on the Klein bottle admits an equivalent straight-line representation on the flat Klein bottle.*

Having a simple triangular map on the Klein bottle, the results of Section 2 show that there is a sequence of edge contractions leading to the map with a single vertex and three loops (see the proof of Theorem 3.1). The proof of Theorem 4.1 is then a simple consequence of the following lemma.

Lemma 4.2. *If M is a simple triangular map on the Klein bottle without potentially contractible edges then M is equivalent to one of the straight-line maps of Fig. 6(a) or (b).*

Proof. Consider one of the loops. Up to homeomorphisms of the surface there are three possibilities for the homotopy class of this loop. It may be separating (non-contractible), 2-sided and non-separating, or 1-sided. The three types of the loops are represented in Fig. 7 as α , β , γ , respectively. It is easy to see that in case when the

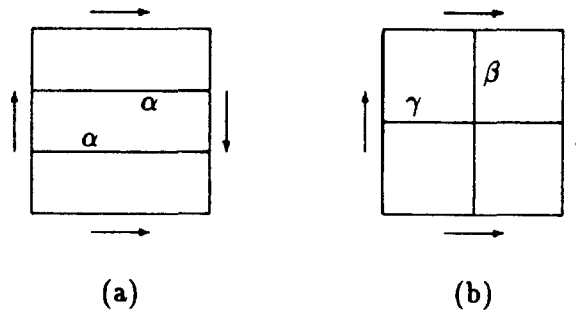

Fig. 7. Simple closed curves on the Klein bottle.

loop is separating, the other two loops are 1-sided and that we have a map equivalent to the map in Fig. 6(a).

Suppose now that all three loops are non-separating. Since the genus of the Klein bottle is 2, there are at most two (pairwise) non-homotopic 1-sided loops. So one of them is 2-sided. On any non-orientable triangulated surface which is 2-cell decomposed by loops, at least one of the loops is 1-sided. That loop must cross the first one. The submap consisting of these two loops is thus equivalent to the map in Fig. 7(b). It has one 4-gonal face. Since our map is triangular, the third loop joins opposite angles of the 4-gon. The two possibilities are isomorphic. We get the map of Fig. 6(b). \square

5. The cylinder and the Möbius band

To get a corresponding result for the remaining flat compact surfaces — the cylinder and the Möbius band — we need to determine their minimal simple triangular maps.

Lemma 5.1. *The only simple triangular maps of the cylinder and the Möbius band having no potentially contractible edges are shown in Fig. 8(a) and (b), respectively.*

Proof. The cylinder has two boundary components. Each of them must have a loop on it. Denote by v_1 and v_2 the two vertices on the boundary. Any new loop at v_i ($i = 1, 2$) is either contractible, or homotopic to the loop on the boundary. Therefore, the remaining edges join v_1 and v_2 . For one of them there is only one possibility (up to equivalence). The other one must go around in order not to be homotopic to the first one. The resulting map is shown in Fig. 8(a).

The Möbius band has one boundary component, so we will have only one vertex. There is a loop on the boundary. It follows by the Euler's formula that there is exactly one more loop. Any simple closed curve on the Möbius band goes t -times around, where $t \in \{0, 1, 2\}$. To get a simple triangular map the only possibility is $t = 1$ which gives the map of Fig. 8(b). \square

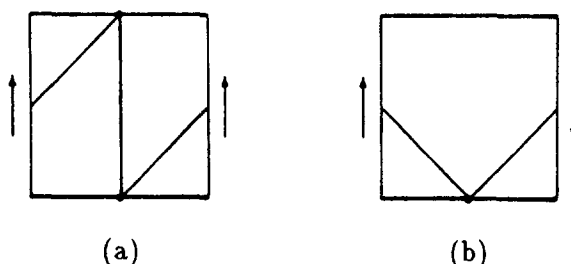

Fig. 8. The cylinder and the Möbius band.

The consequence is our final result.

Theorem 5.2. *Every simple map of the cylinder or the Möbius strip has a straight-line representation in the flat cylinder, or the flat Möbius strip, respectively.*

One can use the Möbius strip representations to get straight-line drawings of graphs embedded in the projective plane.

References

- [1] E.M. Andreev, On convex polyhedra in Lobachevskii spaces, *Mat. Sb. (N. S.)* 81 (1970) 445–478; Engl. transl. in *Math. USSR Sb.* 10 (1970) 413–440.
- [2] E.M. Andreev, On convex polyhedra of finite volume in Lobachevskii space, *Mat. Sb. (N.S.)* 83 (1970) 256–260; Engl. transl. in *Math. USSR Sb.* 12 (1970) 255–259.
- [3] M.P. do Carmo, *Differential Geometry of Curves and Surfaces* (Prentice-Hall, Englewood Cliffs, NJ, 1976).
- [4] I. Fáry, On straight representations of planar graphs, *Acta Sci. Math. Szeged* 11 (1948) 229–233.
- [5] P. Gritzmann, The toroidal analogue to Eberhard’s Theorem, *Mathematika* 30 (1983) 274–290.
- [6] J.L. Gross and T.W. Tucker, *Topological Graph Theory*, (Wiley-Interscience, New York, 1987).
- [7] B. Grünbaum, and G.C. Shephard, *Tilings and Patterns* (Freeman, New York, 1987).
- [8] P. Koebe, Kontaktprobleme auf der konformen Abbildung, *Ber. Verh. Saechs. Akad. Wiss. Leipzig, Math.-Phys. Kl.* 88 (1936) 141–164.
- [9] P. Mani-Levitska, B. Guigas and W.E. Klee, Rectifiable n -periodic maps, *Geom. Dedicata* 8 (1979) 127–137.
- [10] B. Mohar and C. Thomassen, *Graphs on surfaces*, in preparation.
- [11] E. Steinitz, Polyeder und Raumeinteilungen, *Enzykl. Math. Wiss., Part 3AB12* (1922) 1–139.
- [12] W.P. Thurston, *The geometry and topology of 3-manifolds*, Princeton Univ. Lect. Notes (Princeton, NJ).
- [13] K. Wagner, Bemerkungen zum Vierfarbenproblem, *Jber. Deutsch. math. Verein.* 46 (1936) 26–32.